

OPERACION 1

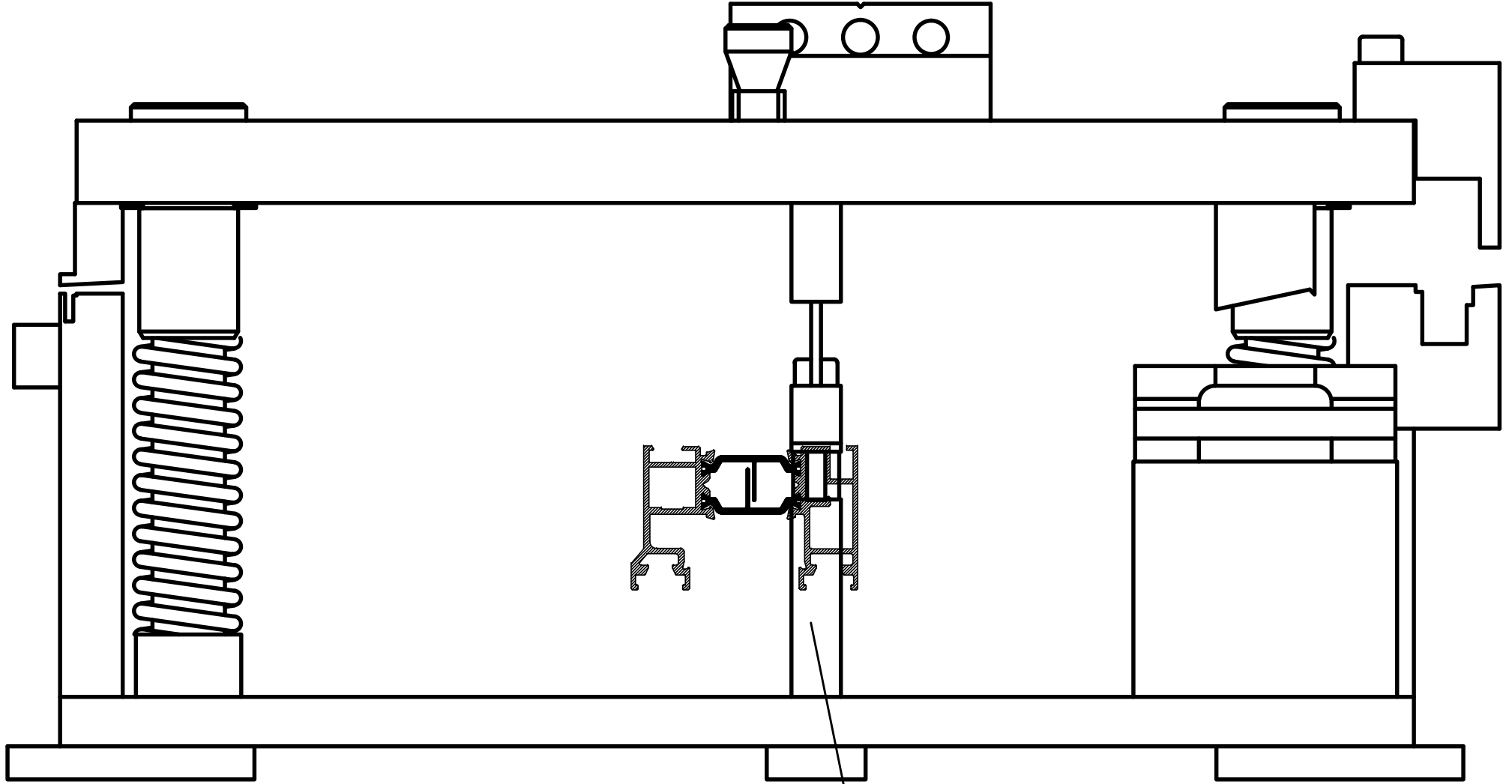

OPERACION J

OPERACION A

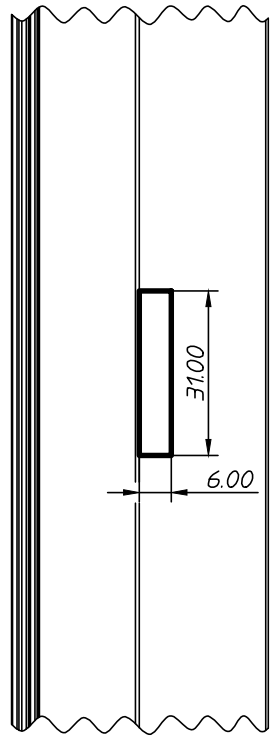
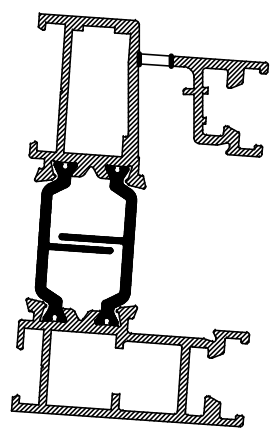

OPERACION B

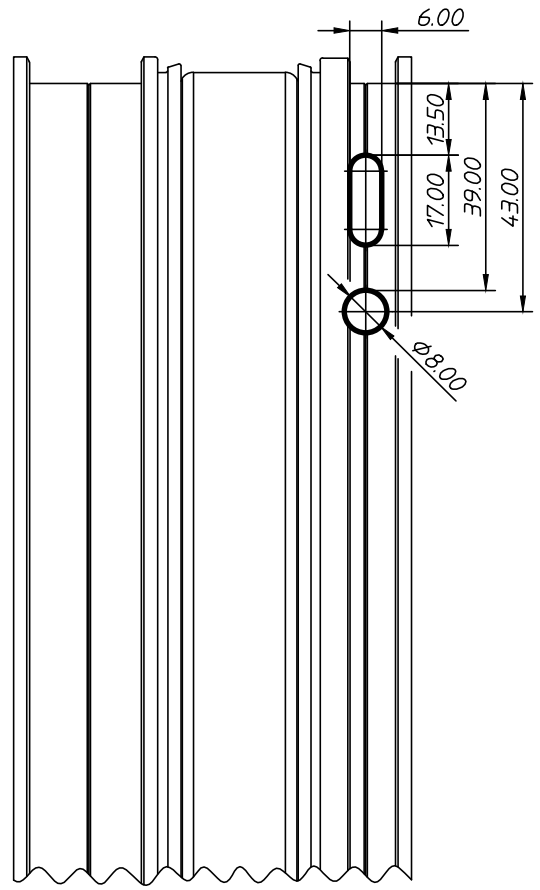
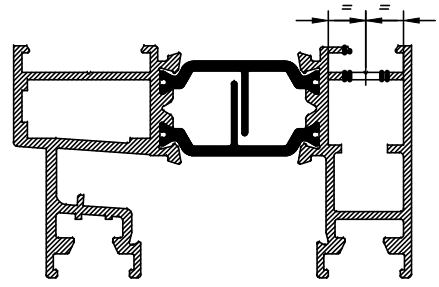

OPERACION C

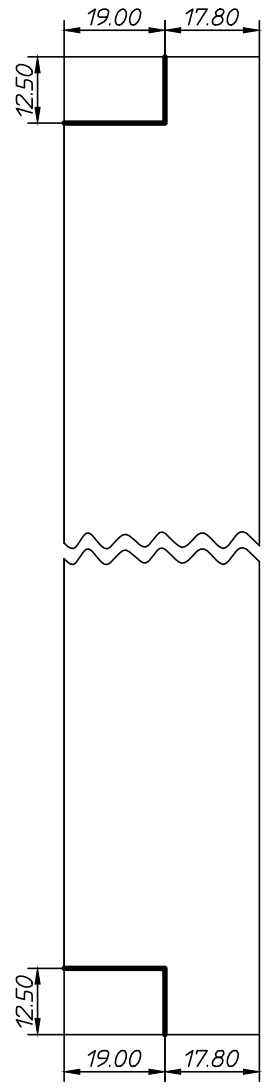
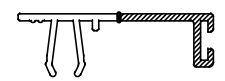

OPERACION D

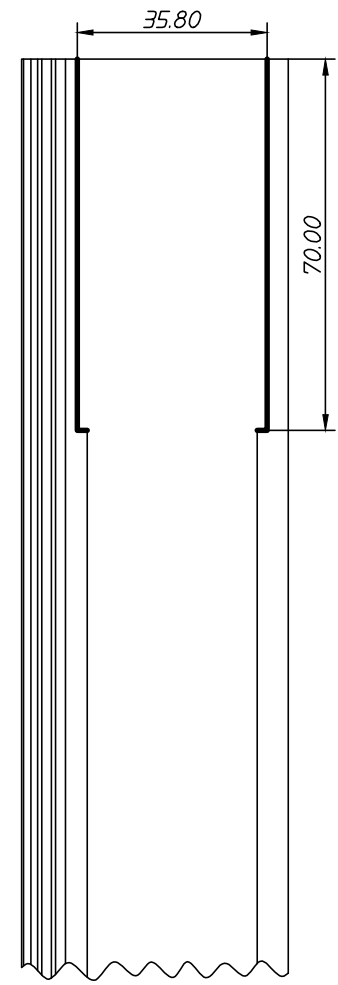
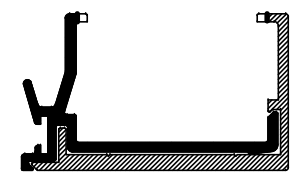

OPERACION F

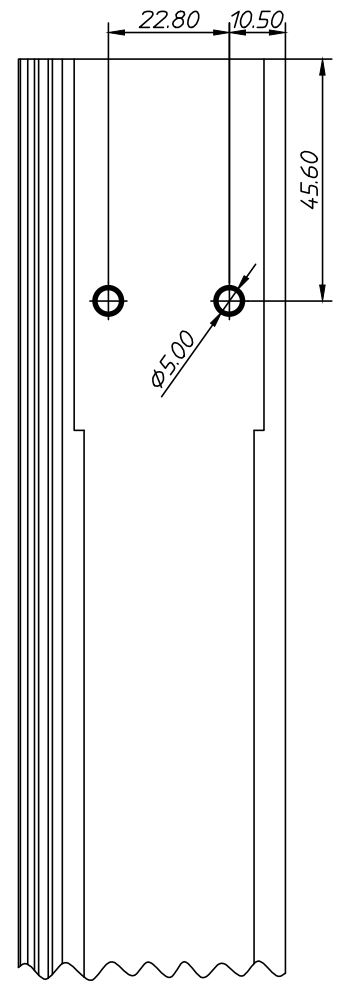
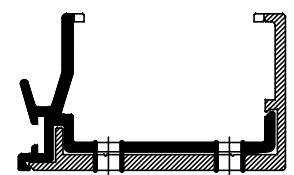

REALIZAR ANTES OPERACION D

OPERACION E

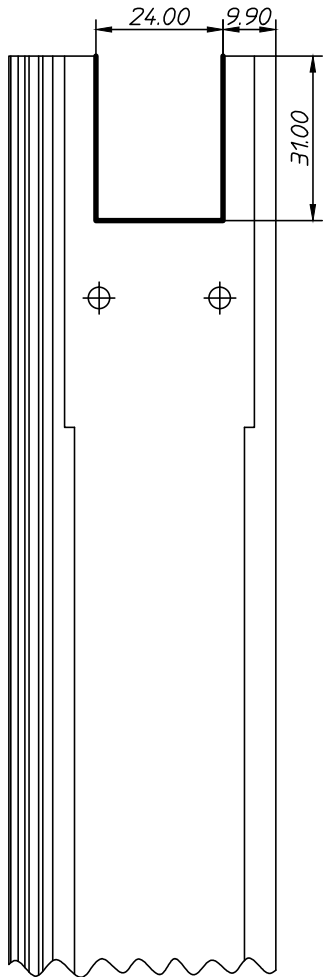
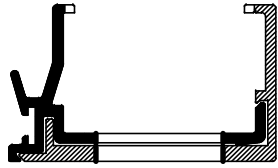

REALIZAR ANTES OPERACION F

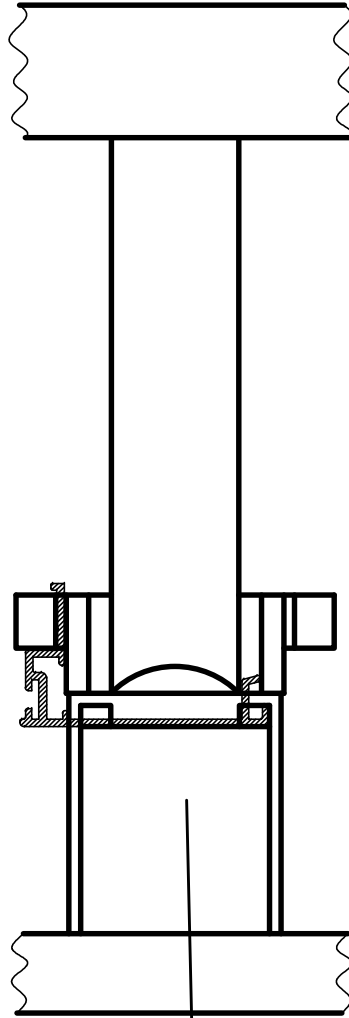

OPERACION E

OPERACION E

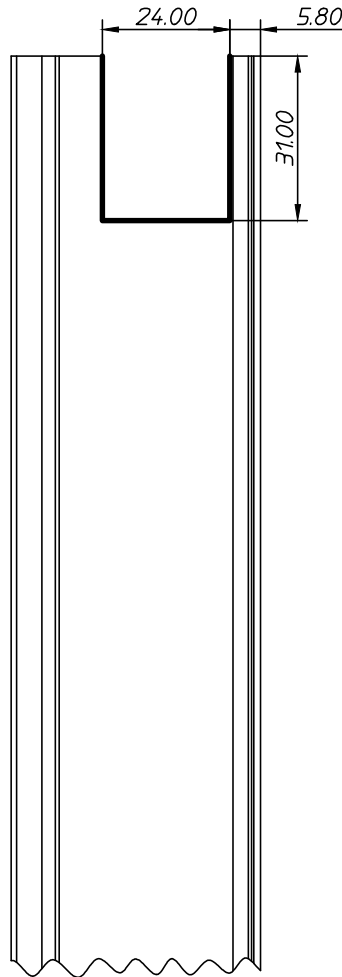
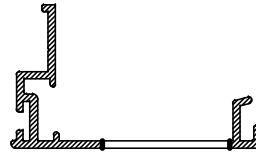

OPERACION H

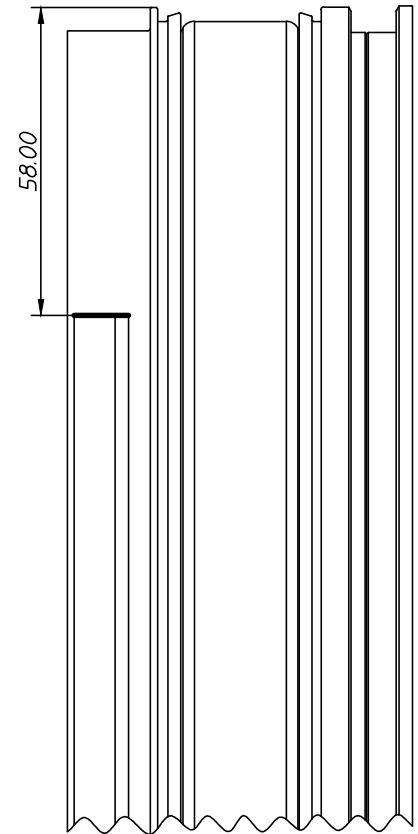
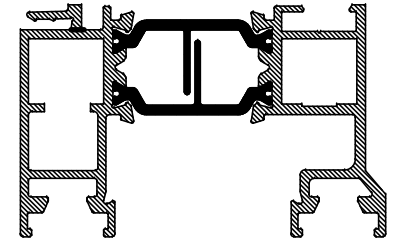

REALIZAR OPERACION EN TRES GOLPES

OPERACION G

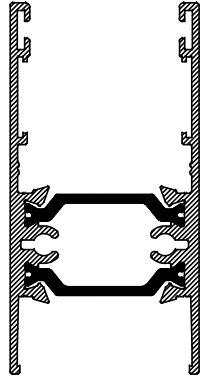

OPERACION G

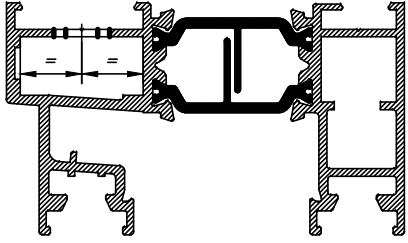

OPERACION I

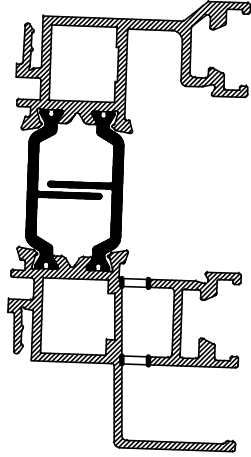

OPERACION I

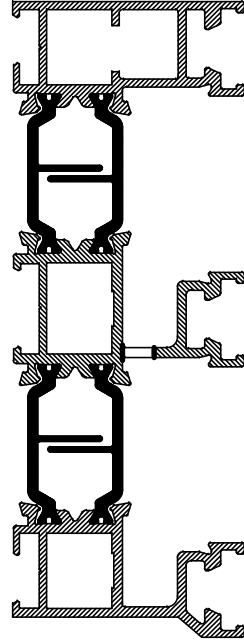

OPERACION J

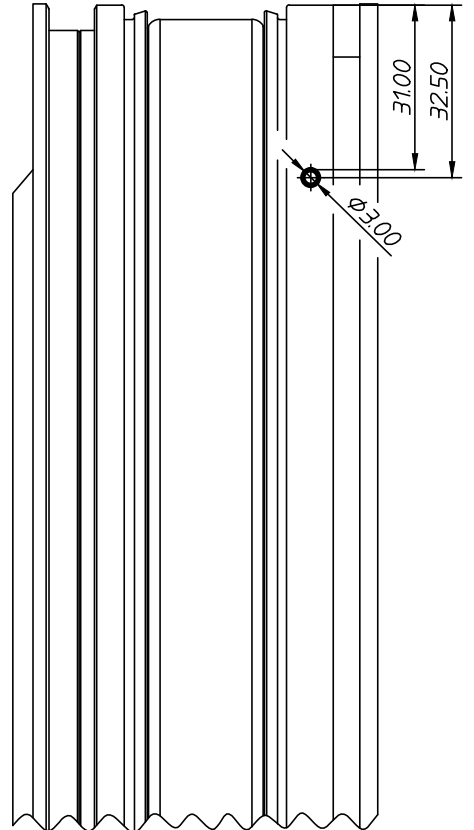
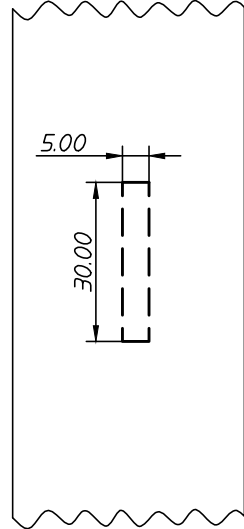
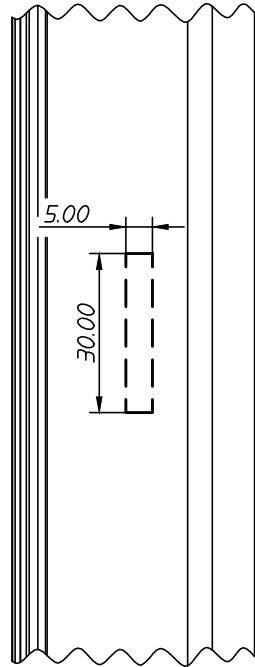
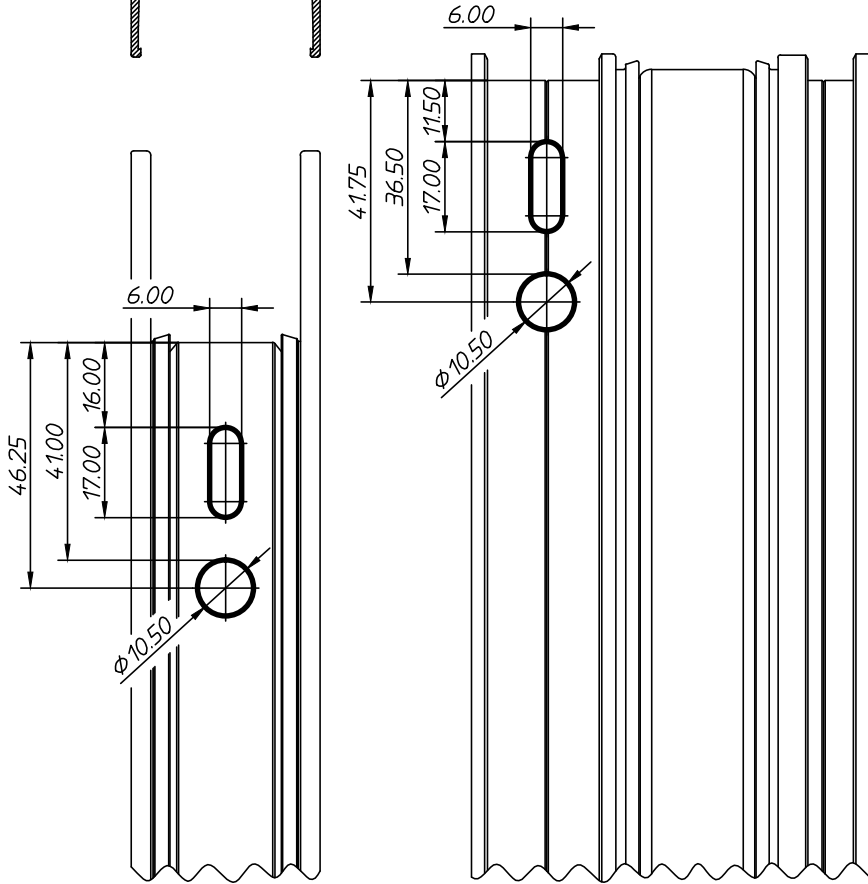
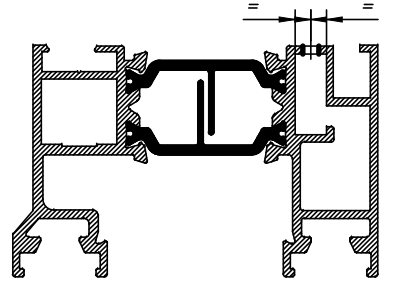

COLOCAR SUPLEMENTO "U"

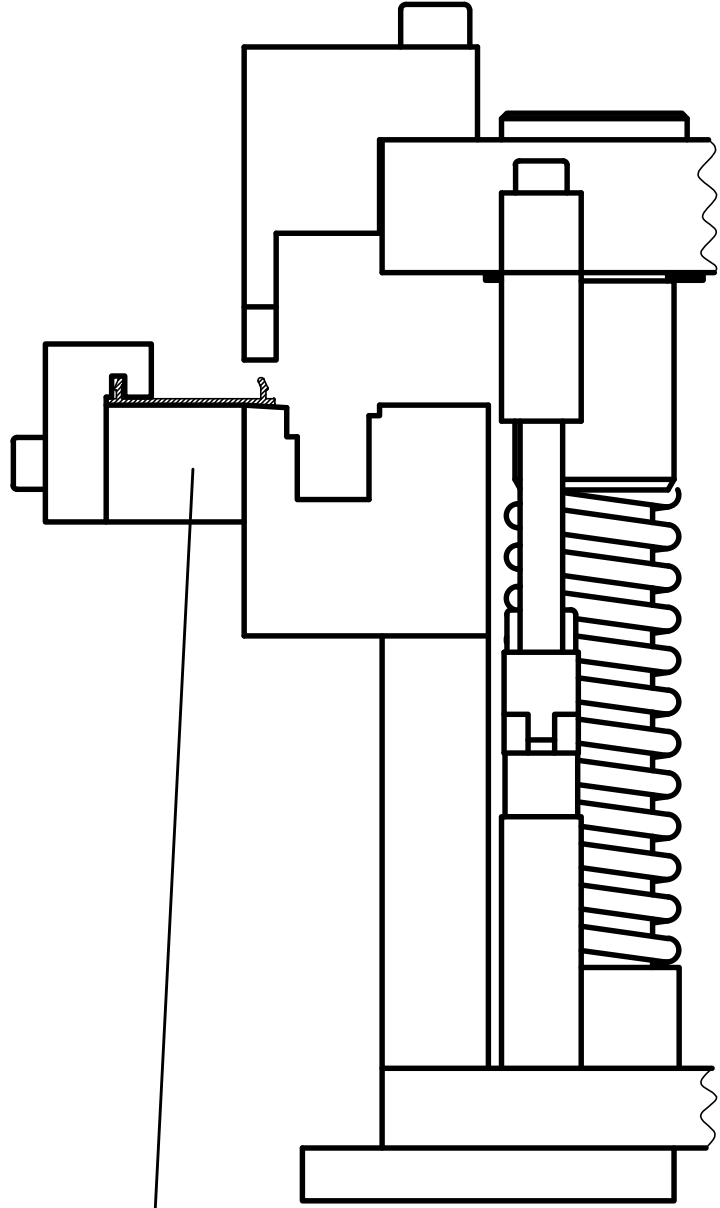

OPERACION K

OPERACION K

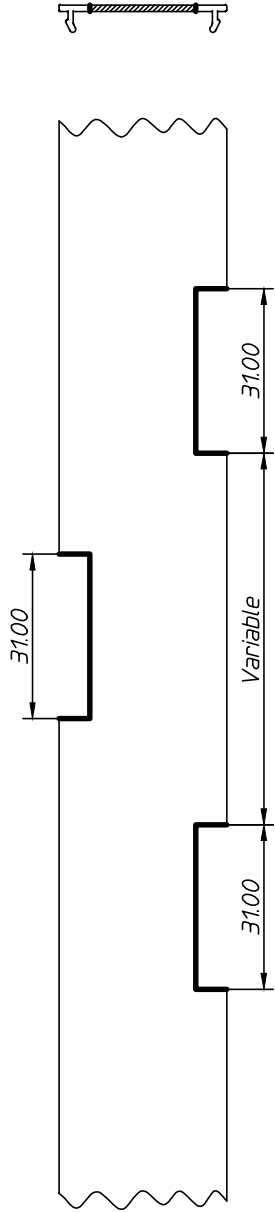

OPERACION L

OPERACION L

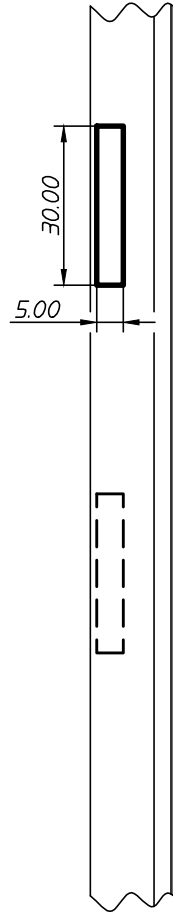
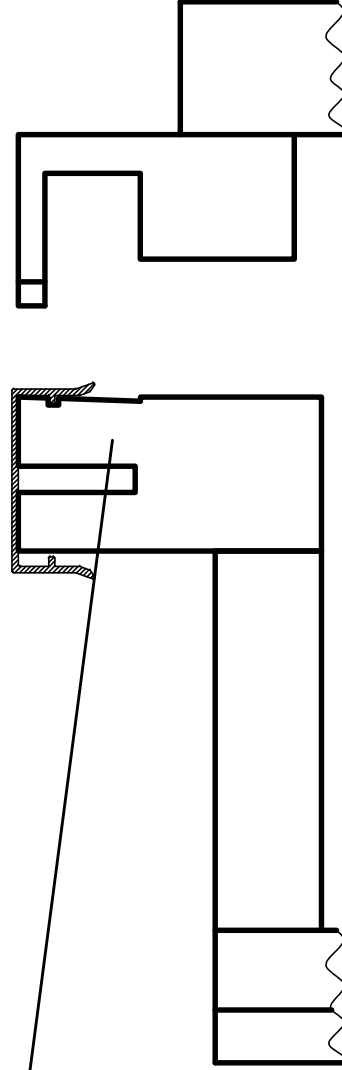

OPERACION M

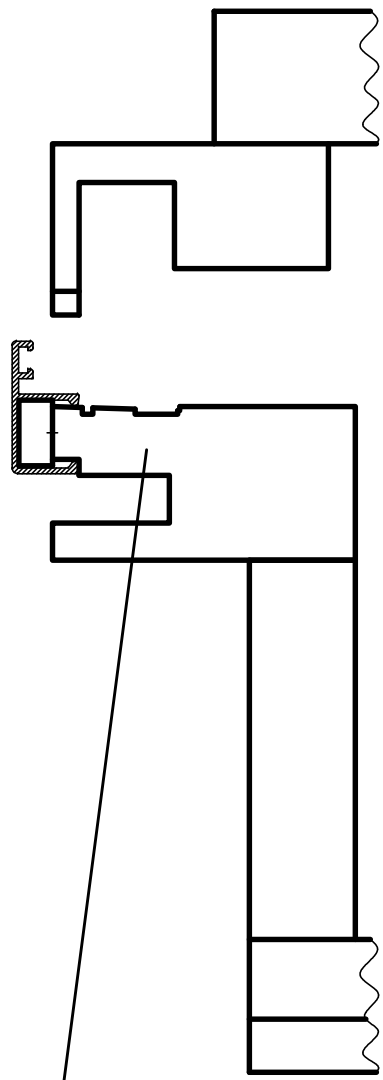

OPERACION M

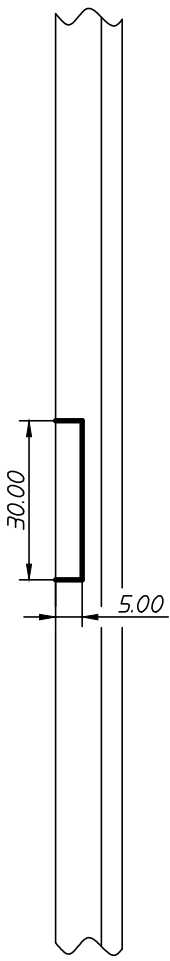
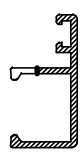

OPERACION N (Manual)

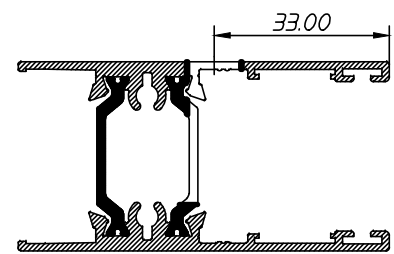
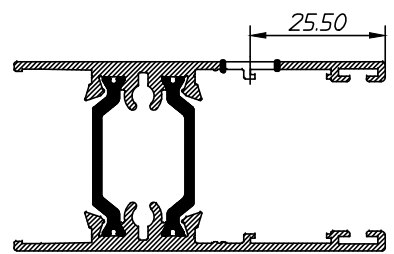

MECANIZADO EN PLANTILLA

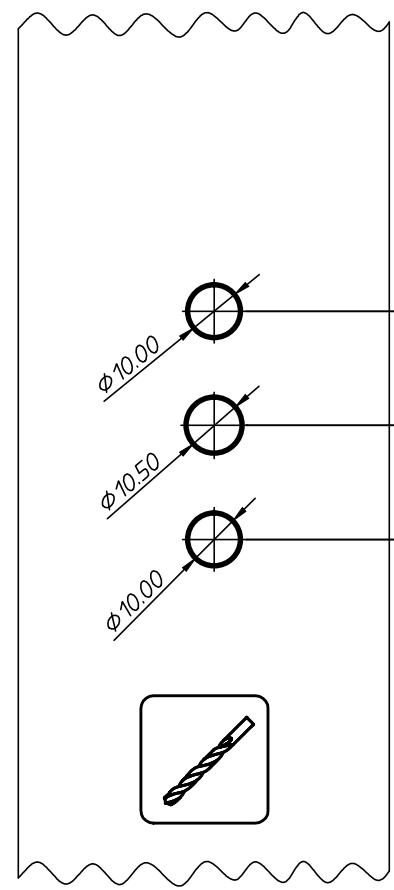
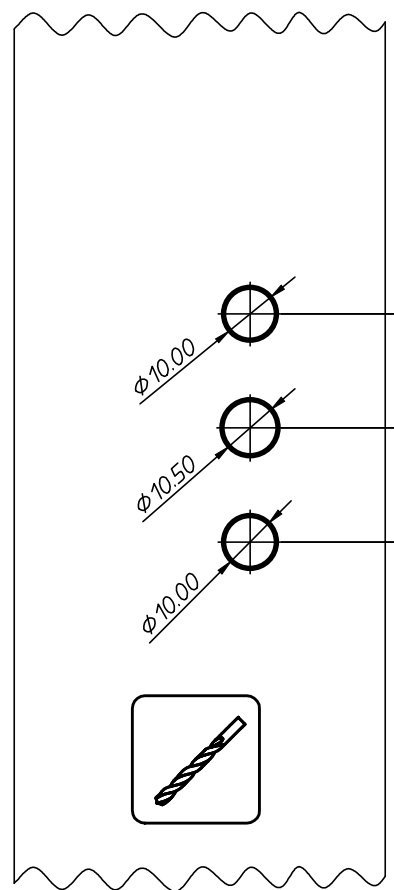

COLOCAR SUPLEMENTO

