

ALUGOM

Serie

ALG 65 ÓPTIMA HS

Especificaciones Técnicas

Carpintería practicable con Rotura de Puente Térmico

Cámara Europea

Junta abierta con Junta Central

Sección de Marco..... 65 mm

Sección de Hoja..... 59,5 mm

Acrilamiento Hoja..... 8 - 42 mm

Acrilamiento Cerco..... 9 - 43 mm

Incluyen Juntas Acrilalar

junquillos de altura 22 mm

Peso Máximo por : Hoja Practicable **100 kg**(1)Hoja Oscilo Batiente **140 kg**(1)

Medidas Máximas por Hoja para todas las aperturas :

1700 mm x 2500 mm(1)

(1) Consultar rangos de aplicación con nuestro Departamento Técnico. Con herraje OCULTO.

Clasificación Obtenida

Permeabilidad al aire*	CLASE	4
Estanqueidad al agua*	CLASE	E900
Resistencia al viento*	CLASE	C5
<hr/>		
Transmitancia térmica** Uw		1.2 W/m² K
Transmitancia térmica con HQ** Uw		1.1 W/m² K
Transmitancia térmica Uf (Nudo lateral)^		2.3 W/m² K
Transmitancia térmica Uf con "HQ" ^		2.1 W/m² K
Aislamiento Acústico***		46 (-2;-5) dB

* Ventana de 2 hojas de 1230 x 1480 mm

** Ventana de 2 hojas de 1700 x 2335 mm; vidrio Ug: 0,6 W/m² K - UNE-EN ISO 10077-1:2010

*** Ventana de 2 hojas de 1230 x 1480 mm; vidrio 4+4 Silence/16/5+5 Silence - UNE-EN ISO 10140-2:2011

^ Según normativa UNE-EN ISO 10077-2:2020

Posibilidades de Apertura

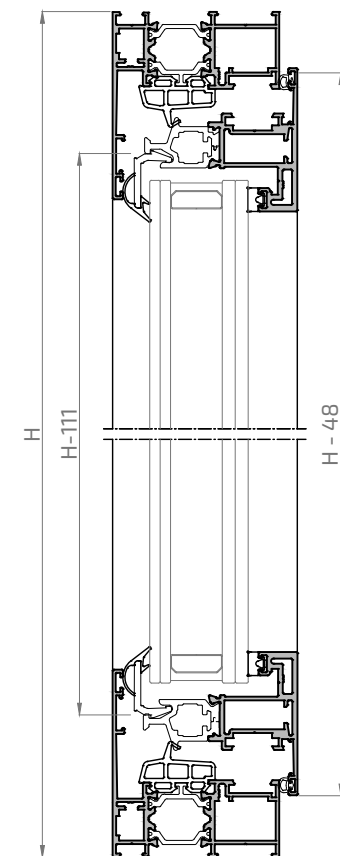
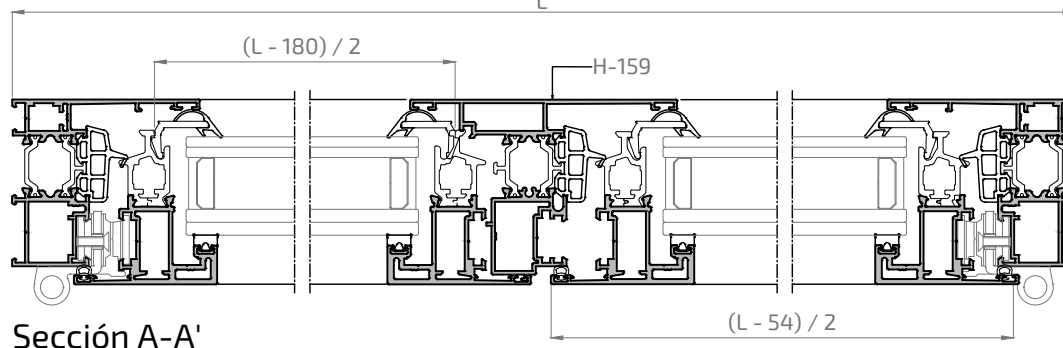
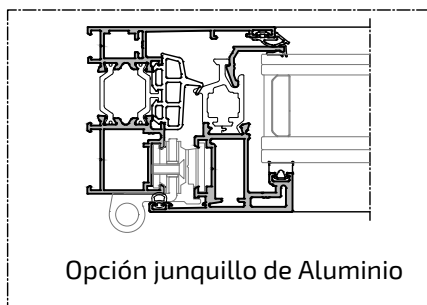
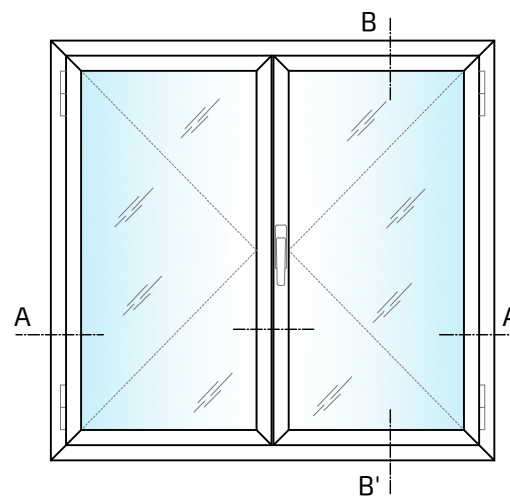
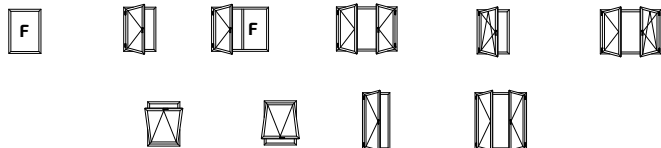

Los ensayos de las ventanas realizados por ALUGOM, que son cedidos para la obtención del marcado CE por parte del cliente, se han realizado con los perfiles y accesorios específicos y concretos propuestos por ALUGOM, que figuran en los manuales de fabricación de cada serie. Para más información consultar con el departamento técnico ALUGOM.

Perfiles

ALG 65 ÓPTIMA HS

16779L
Cercos 30 mm ALG 65 HS

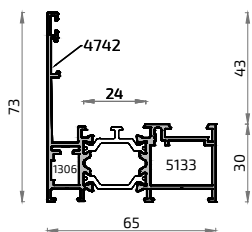

16764L **NO STOCK**
Cercos 27 mm ALG 65 HS

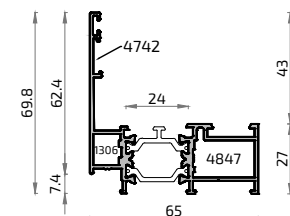

8190L **NO STOCK**
Cercos Solape 30 mm ALG 65 HS

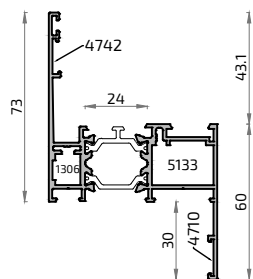

21428L
Hoja Alg 65 Acrist. 43 mm

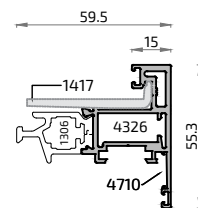

20223L
Hoja ALG 65 HS

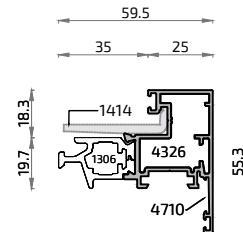

16766L
Acople Inversora ALG 65 HS

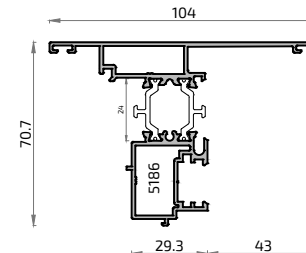

20560L
Pilastra reducida hoja oculta

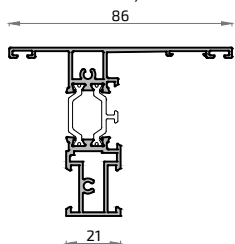

16767L
Pilastra asimétrica 30 mm ALG 65 HS

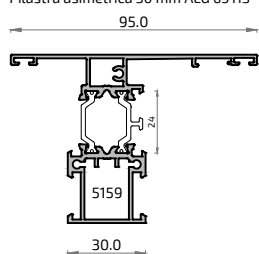

16768L
Pilastra Simétrica 50 mm ALG 65 HS

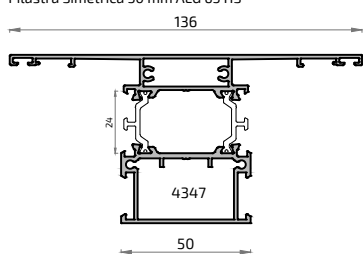

717 1207
Acople junquillo alg HS

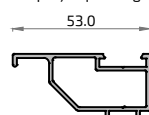

20218
Junquillo Largo 36 mm

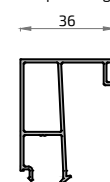

20217
Junquillo Largo 28 mm



20318
Junquillo Largo 21.5 mm



20334
Junquillo Largo 14.5 mm

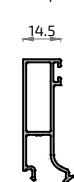

21087
Junquillo Largo 10.5 mm



18898L
Esquinero Regulable Macho 65 mm

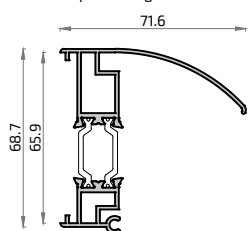

18897L
Esquinero Regulable Hembra 65 mm

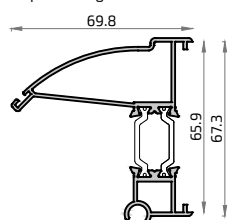

10006M
Esquinero 90° Curvo

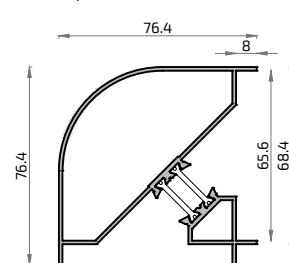

18215L
Esquinero 90° Recto

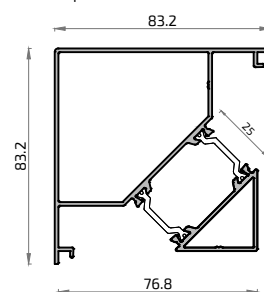

20271
Junquillo alg HS

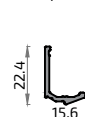

16319L **NO STOCK**
Condensación 65 mm ALG 65

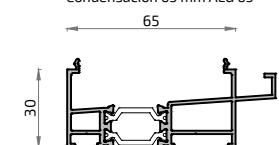

20075
Unión Cercos alg

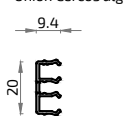

20093
Junta Cercos Garganta alg

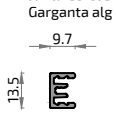

10077
Reductor de Vidrio 10 mm



10078
Reductor de Vidrio 12 mm



9829
Reductor de Vidrio 18 mm



8412
Pletina Falleba



8428
Vierteaguas



16321
Solapa Clip 30 mm

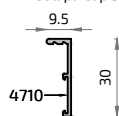

16322
Solapa Clip 45 mm

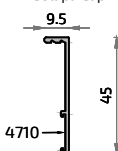

16323
Solapa Clip 65 mm

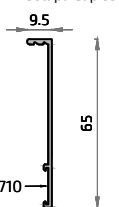

8482L
Unión de Cercos ALG 65

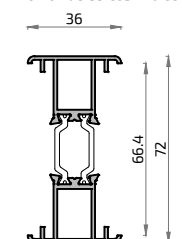

Detalles Técnicos
2

Accesorios

















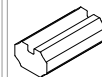

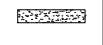









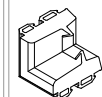











ALG 65 ÓPTIMA HS

Cremonas y Manillas	5590 Cremona KORA oscilo	5600 Cremona KORA batiente	A22001 Cremona Kora c/llave	4704 Cremona EURO AWAY	4705 Mango extraíble EURO	5475 Cremona ASIA oscilo	5497 Cremona ASIA batiente	4725 Cremona PRIMA oscilo	4792 Cremona PRIMA KEY oscilo	4723 Cremona PRIMA batiente	4761 Cremona PRIMA KEY batiente	5022 Cremona PRIMA industrial	4190 Manilla BÁSICA c/7	5183 Manilla BÁSICA c/7 llave	5398 Manilla ATLANTA c/7	5389 Manilla TOULON c/7	5191 Manilla KORA c/7	
	5583 Manilla WONDER c/7 derecha	5584 Manilla WONDER c/7 izquierda	5079 Manilla PREMIUM	5080 Manilla PREMIUM con llave	5147 Manilla NP ULTRA Alugom	5143 Manilla NP ULTRA cuadrada	5144 Manilla NP ULTRA redonda	5535 Manilla NP Redonda con Llave	5532 Manilla KORA 175 c/8	Escuadras		1306 Escuadra exterior	4847 Escuadra cerco/hoja	4326 Escuadra hoja balconera	4742 Escuadra cerco y hoja	5133 Escuadra cerco	4710 Escuadra alineamiento 14 mm	Bisagras
4727 Bisagra FLASH derecha	4728 Bisagra FLASH izquierda	4768 Bisagra 3ª hoja	4769 Bisagra extremo "jirafa"	4352 Bisagra ventana 3 hojas	4316 Bisagra apertura externa	A23006 Bisagra oculta Canal EU. CHIC	A21015 Kit bisagra CHIC Abatible	A21016 Resbalón CHIC abatible	4744 Bisagra balcón 24,5 mm	A25049 Bisagra puerta (CE) Fulcra	Mecanismo de apertura		4613 Mecanismo bidireccional PRACT.	5145 Mecanismo NP PRACT.	5081 Mecanismo unidireccional OS-BA	5399 Mecanismo NP OS-BA.	5153 Mec. unidireccional APERT. EXTERNA 33,5 mm	5527 Mecanismo bidireccional APERT. EXTERNA 29 mm
5154 Cuadradillo 7 x 80 mm	Varios		5122 Pieza soporte clip plano	5121 Pieza soporte clip exterior	5120 Pieza soporte clip interior	4012 Clip guía	4008 Patin apoyo hoja	4078 Pieza sujeción junquillo curvo	5178 Solera 70 mm	4971 Cepillo Fin Seal 7 x 15 mm	5425 Escuadra junquillos curvos	A23178 Motor VARIA SLIM CADENA	Elementos de Cierre		4720 Cerradero lateral doble pletina Zamak	4004 Cerradero lateral doble pletina nylon	4842 Cerradero superior regulable oscilo	4005 Cerradero lateral pletina nylon
4025 Kit cremona	4739 Terminal pletina metálico	4003 Terminal de pletina cremona	4840 Kit pasador hoja pasiva metálica (sup. e inf.)	4025 Kit cremona	4380 Kit cremona 2 hojas	4860 Pasador bidireccional palanca	4714 Kit cremona 1 hoja	4731 Pasador INCA 2ªH Canal 18	4002 Pasador oculto longitud variable	4007 Cierre complementario cremona	5002 Cerradero complementario	4366 Cierre bisagra oculta	5450 Tercer punto de cierre CHIC	4010 Compás corto RALLENTY	4085 Compás largo RALLENTY 250	4011 Compás LASER telescópico	4848 Microventación batiente	
5040 Limitador apertura	4754 Retenedor de hoja	4873 Pasador palanca perimetral	5026 Bulón regulable	4846 Tercer punto de cierre	4002 4003 (2 uds) (2 uds)	4003 (2 uds) 4005 (2 uds)	4025	4008										

Detalles Técnicos
2

Accesorios

ALG 65 ÓPTIMA HS

Tapas	5186 Tapa inversora alg65 HS 	4994 Tapa rígida canal 	4337 Embellecedor salida aguas c/válvula 	4035 Embellecedor salida aguas 	Termo Perfiles HQ	5090 Termoperfil [D] (19 x 13 mm) 	5088 Termoperfil [B] (10 x 10.5 mm) 	5109 Termoperfil [R] (17 x 14.5 mm) 	5116 Termoperfil [TS] (34.5 x 23.5 mm) 	5096 Aislante vidrio 36 X 5 mm 	5097 Banda aislante cerco 26 x 5 mm 	Tacos	5159 Taco pilastra 30 mm 	4347 Taco pilastra 50 mm 	Juntas	5018 Junquillo Coextrusión 	A22020 Junta cerco HS 
	A22021 Junta Junquillo HS 	A25033 Junta co-extruida de EPDM 	5488 Junta paso inferior 	5180 Refuerzo junta central HS 	5581 Junta central celular ALG 65 HS 	5073 Junta central 	A21022 Ángulo vulcanizado ALG 65 HS 	5105 Ángulo vulcanizado junta central 	5194 Junta interior acristalamiento de 2 mm 	1337 Junta interior acristalamiento de 3 mm 	1338 Junta interior acristalamiento de 4 mm 	4089 Junta interior acristalamiento de 5 a 6 mm 	4091 Junta interior acristalamiento de 7 a 8 mm 	5261 Junta interior acristalamiento de 9 a 10 mm 	4057 Junta exterior acristalamiento 	4850 Junta exterior acristalamiento alas 	1311 Junta interna vidrio 2.4 mm 
1313 Junta interna vidrio 4.4 mm 	1314 Junta interna vidrio 6.4 mm 	1315 Junta interna vidrio 8.4 mm 	1316 Junta interna vidrio 10.4 mm 	1361 Junta interna vidrio 11.4 mm 	1317 Junta interna vidrio 12.4 mm 	1362 Junta interna vidrio 13.4 mm 	1318 Junta interna vidrio 14.4 mm 	A23019 Junta acristalamiento 	5155 Adhesivo poliuretano 	1414 Calzo Acristalamiento de 40 mm 	1417 Calzo Acristalamiento de 48 mm 						

Representación gráfica termo perfiles

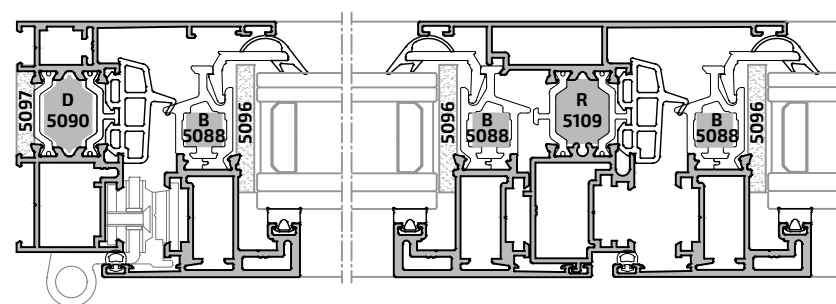

Útiles

- 5112 Útil sistema alg
- 5525 Útil sistema alg
- 5015 Plantilla escuadra exterior
- 4729 Bobina pletina poliamida
- A23104 Útil alg VISTA y HS

Fresas

- 5198 Fresa Cerco ALG 65 Óptima HS

Varios

- Ver ampliado en página según índice:
- Accesorios Oscilo batiente
 - Kit Oscilo batiente
 - Herraje oculto
 - Kit Oscilo Paralela
 - Cerraduras en apartado 7.9

ALTURA JUNQUILLO = 43 mm	36 mm	28 mm	21,5 mm	14,5 mm	10,5 mm
PERFILES	20218	20217	20318	20334	21087
CERCOS: 16779L 16764L 8190L					
PILASTRAS: 16767L 16768L					
VIDRIO DE 12 mm	●				
VIDRIO DE 13 mm	●				
VIDRIO DE 14 mm	●				
VIDRIO DE 15 mm	●				
VIDRIO DE 16 mm	●				
VIDRIO DE 17 mm	●				
VIDRIO DE 18 mm	●				
VIDRIO DE 19 mm	●				
VIDRIO DE 20 mm		●			
VIDRIO DE 21 mm		●			
VIDRIO DE 22 mm		●			
VIDRIO DE 23 mm		●			
VIDRIO DE 24 mm		●			
VIDRIO DE 25 mm		●			
VIDRIO DE 26 mm		●			
VIDRIO DE 27 mm			●		
VIDRIO DE 28 mm			●		
VIDRIO DE 29 mm			●		
VIDRIO DE 30 mm			●		
VIDRIO DE 31 mm			●		
VIDRIO DE 32 mm			●		
VIDRIO DE 33 mm			●		
VIDRIO DE 34 mm				●	
VIDRIO DE 35 mm				●	
VIDRIO DE 36 mm				●	
VIDRIO DE 37 mm				●	
VIDRIO DE 38 mm				●	
VIDRIO DE 39 mm				●	
VIDRIO DE 40 mm					●
VIDRIO DE 41 mm					●
VIDRIO DE 42 mm					●
VIDRIO DE 43 mm					●
VIDRIO DE 44 mm					●
VIDRIO DE 45 mm					●

- Juntas Exteriores
- A23019
- 4057
- 4850

Tabla Acristalamiento Fijo

ALG 65 ÓPTIMA HS

Juntas INTERIORES de acristalamiento					
5194	1337	1338	4089	4091	5261
de 2 mm	de 3 mm	de 4 mm	5 a 6 mm	7 a 8 mm	9 a 10 mm
					●
				●	●
				●	
			●		
	●				●
				●	
			●		
	●				
		●			
	●				●
				●	
			●		
	●				
				●	
			●		
	●				
●	●	●			

La Tabla superior de cálculo del espesor de vidrio para esta serie se ha estudiado con junta interior y exterior de acristalamiento. Si se quisiera acristalar con silicona por la parte interior, se podría ganar algo de medida.

ALTURA JUNQUILLO = 43 mm	36 mm	28 mm	21,5 mm	14,5 mm	10,5 mm
PERFILES	20218	20217	20318	20334	21087
CERCOS: 16779L 16764L 8190L					
ALTURA JUNQUILLO = 22 mm	35,5 mm	28,5 mm	21,5 mm	14,5 mm	10,5 mm
PERFILES	8820	8625	16866	8825	8827
PILASTRA: 16767L					
VIDRIO DE 12 mm	●				
VIDRIO DE 13 mm	●				
VIDRIO DE 14 mm	●				
VIDRIO DE 15 mm	●				
VIDRIO DE 16 mm	●				
VIDRIO DE 17 mm	●				
VIDRIO DE 18 mm	●				
VIDRIO DE 19 mm	●				
VIDRIO DE 20 mm		●			
VIDRIO DE 21 mm		●			
VIDRIO DE 22 mm		●			
VIDRIO DE 23 mm		●			
VIDRIO DE 24 mm		●			
VIDRIO DE 25 mm		●			
VIDRIO DE 26 mm		●			
VIDRIO DE 27 mm			●		
VIDRIO DE 28 mm			●		
VIDRIO DE 29 mm			●		
VIDRIO DE 30 mm			●		
VIDRIO DE 31 mm			●		
VIDRIO DE 32 mm			●		
VIDRIO DE 33 mm			●		
VIDRIO DE 34 mm				●	
VIDRIO DE 35 mm				●	
VIDRIO DE 36 mm				●	
VIDRIO DE 37 mm				●	
VIDRIO DE 38 mm				●	
VIDRIO DE 39 mm				●	
VIDRIO DE 40 mm					●
VIDRIO DE 41 mm					●
VIDRIO DE 42 mm					●
VIDRIO DE 43 mm					●
VIDRIO DE 44 mm					●
VIDRIO DE 45 mm					●

Juntas Exteriores	A23019	3	
	4057	4	
	4850	4	

Tabla Acristalamiento Fijo

ALG 65 ÓPTIMA HS

Juntas INTERIORES de acristalamiento					
5194	1337	1338	4089	4091	5261
de 2 mm	de 3 mm	de 4 mm	5 a 6 mm	7 a 8 mm	9 a 10 mm
					●
				●	●
			●	●	
	●				●
				●	
		●			
	●				●
			●	●	
		●			
	●				●
			●	●	
				●	
	●				●
			●	●	
		●			
●	●				

La Tabla superior de cálculo del espesor de vidrio para esta serie se ha estudiado con junta interior y exterior de acristalamiento. Si se quisiera acristalar con silicona por la parte interior, se podría ganar algo de medida.

ALG 65 ÓPTIMA HS

TABLA DE ACRISTAMIENTO HOJAS CON JUNTA INTERIOR DE CLIP

CON JUNTA INTERIOR PARA HUECO DE 44 mm

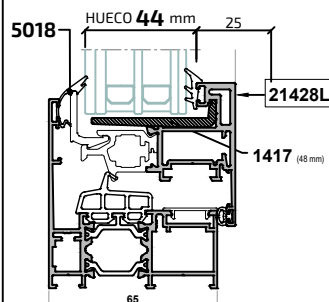

REDUCTOR DE VIDRIO Y JUNTA INTERIOR PARA HUECO DE 34 mm

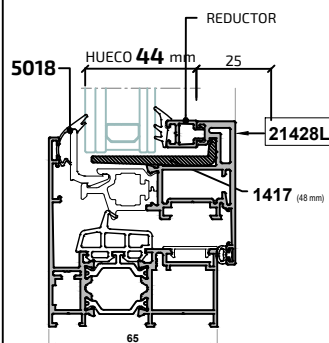

JUNTAS INTERIORES DE ACRISTAMIENTO							
	1311	1312	1313	1314	1315	1316	1361
SOLO CON JUNTA INTERIOR	Vidrios de (en mm)						
VIDRIO DE 42 mm	●						
VIDRIO DE 41 mm		●					
VIDRIO DE 40 mm			●				
VIDRIO DE 39 mm			●				
VIDRIO DE 38 mm				●			
VIDRIO DE 37 mm				●			
VIDRIO DE 36 mm					●		
VIDRIO DE 35 mm					●		
VIDRIO DE 34 mm						●	
VIDRIO DE 33 mm							●
VIDRIO DE 32 mm							●

JUNTAS INTERIORES DE ACRISTAMIENTO							
	1311	1312	1313	1314	1315	1316	1361
SOLO CON JUNTA INTERIOR	Vidrios de (en mm)						
VIDRIO DE 30 mm	+		+				
VIDRIO DE 28 mm			+	+			
VIDRIO DE 26 mm				+	+		
VIDRIO DE 24 mm	+				+	+	
VIDRIO DE 22 mm			+			+	+
VIDRIO DE 20 mm				+			
VIDRIO DE 18 mm					+		
VIDRIO DE 16 mm						+	