

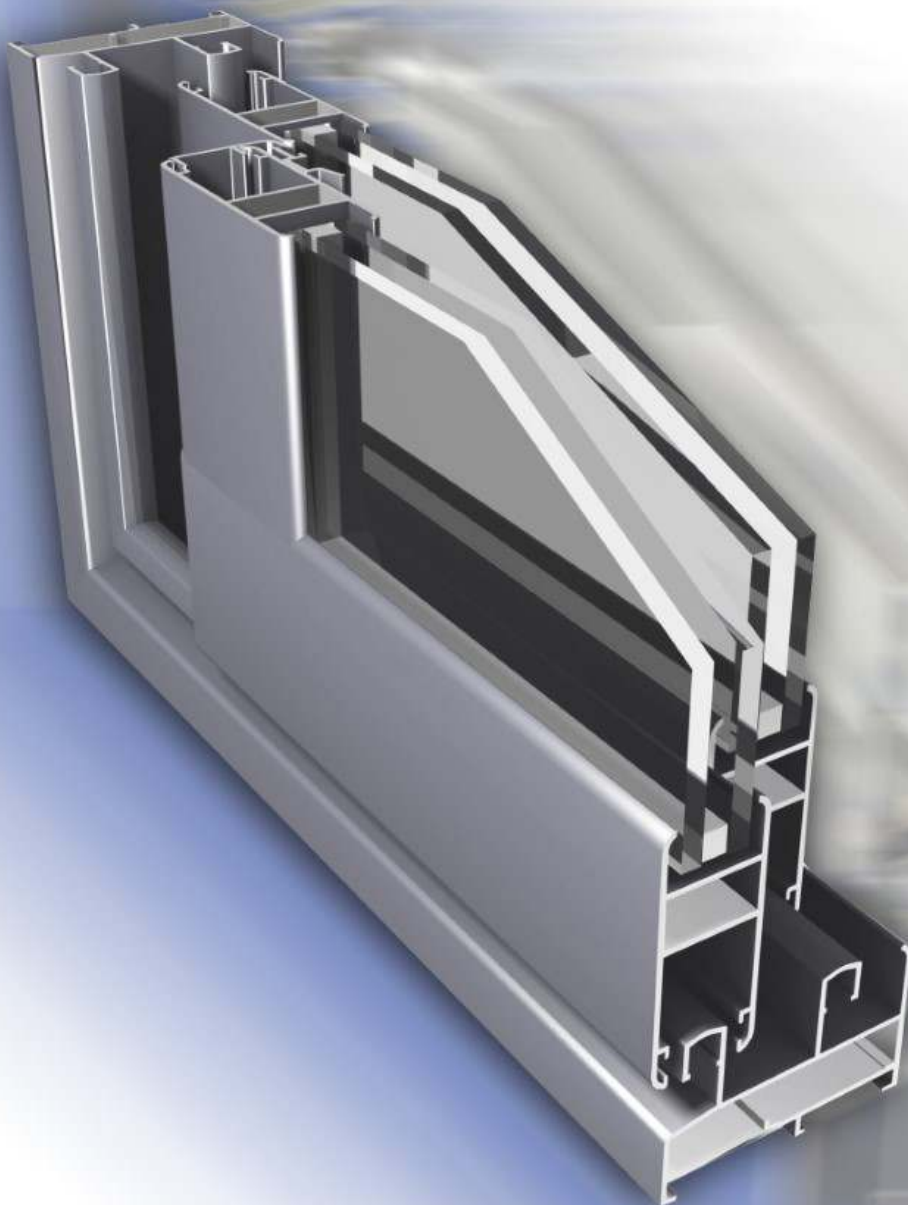

Serie **Silver 60**

Corredera de 60 mm

Lista de Corte



Junio-2019

www.alugom.com



SECCIONES, LISTA DE CORTES Y ACCESORIOS

serie

SILVER-60

SECCION Ventana 2 Hojas Correderas

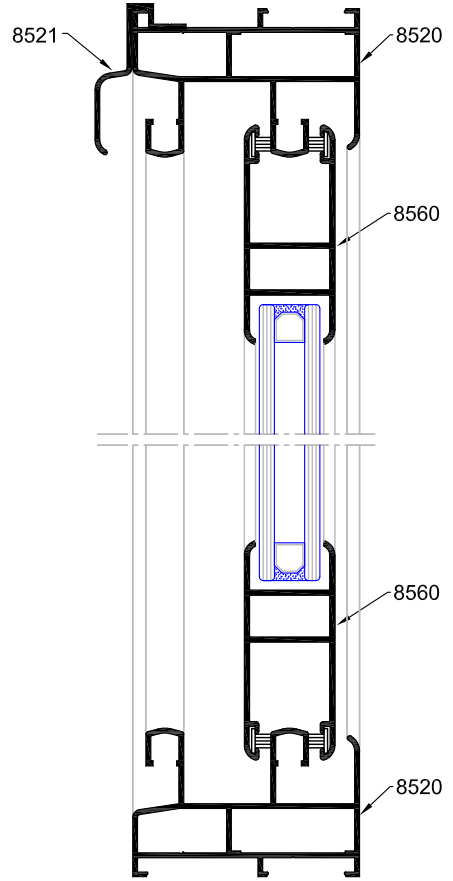
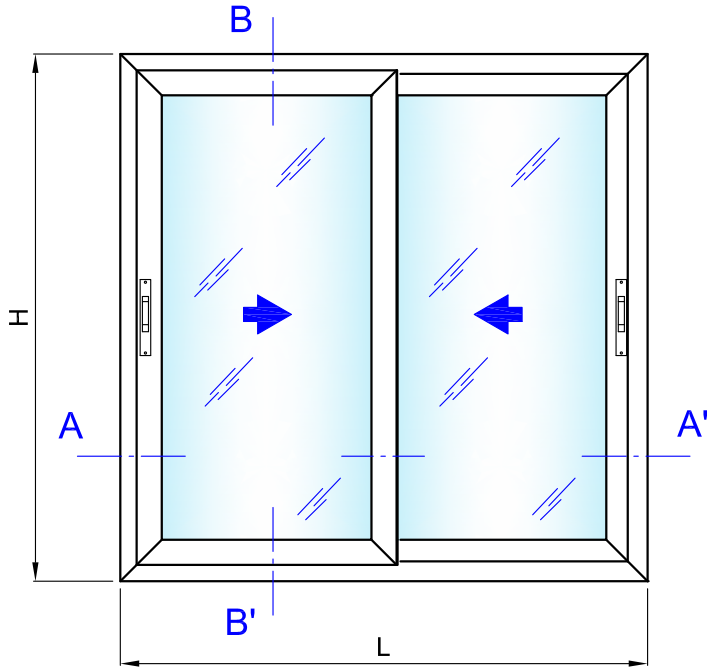

Seccion B-B'

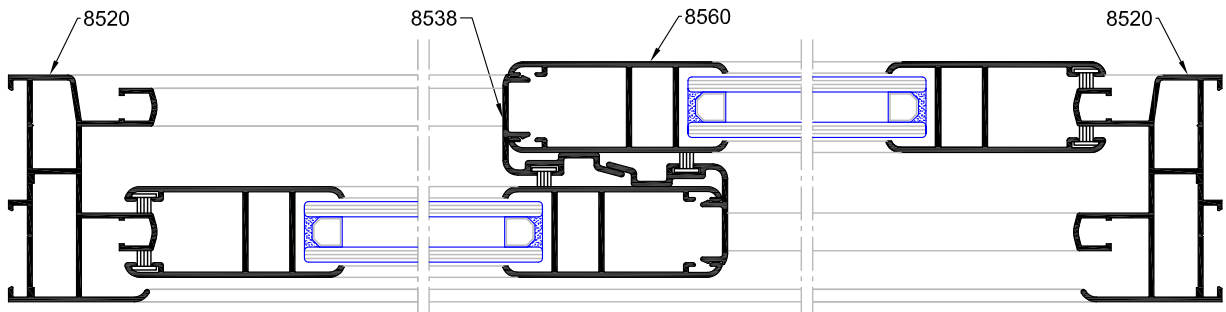

Seccion A-A'



serie

SILVER-60**LISTA DE CORTE Y ACCESORIOS** *Ventana 2 Hojas Correderas*Perfiles

DISEÑO	REFERENCIA	DENOMINACION	POSICION	UNIDADES	FORMULA CORTE	TIPO CORTE
	8520	Cerco Perimetral	Horiz.	2	L	
			Vert.	2	H	
	8560/ 8537	Hoja Perimetral Vidrio doble/sencillo	Horiz.	4	$(L - 4) / 2$	
			Vert.	4	H - 62	
	8538	Acople Cruce Hojas	Vert.	2	H - 62	
	8521	Vieriteguas	Horiz.	1	L	

Vidrio

Unds.	Fórmula Corte
2	$(L-200)/2$ H-158

Accesorios

REFERENCIA	DENOMINACION	CANTIDAD	REFERENCIA	DENOMINACION	CANTIDAD
4558	<i>Cierre Embutido c/ condena</i>	2	4109	<i>Escuadra Alineamiento Hoja</i>	16
4102	<i>Rueda Regulable</i>	4	4116	<i>Escuadra Alineamiento Carriles Cerco</i>	8
4553	<i>Juego Cortavientos</i>	1	4038	<i>Escuadra Cerco</i>	4
4107	<i>Emb. Cruce Central</i>	4	4556	<i>Escuadra Hoja</i>	8
4182	<i>Tope Guiador Lateral (Jgo 4)</i>	1	2022	<i>Fin Seal de 7 x 6,5 mm.</i>	4L,6H

serie

SILVER-60

SECCION Ventana 3 Hojas Correderas Cerco 2 Carriles

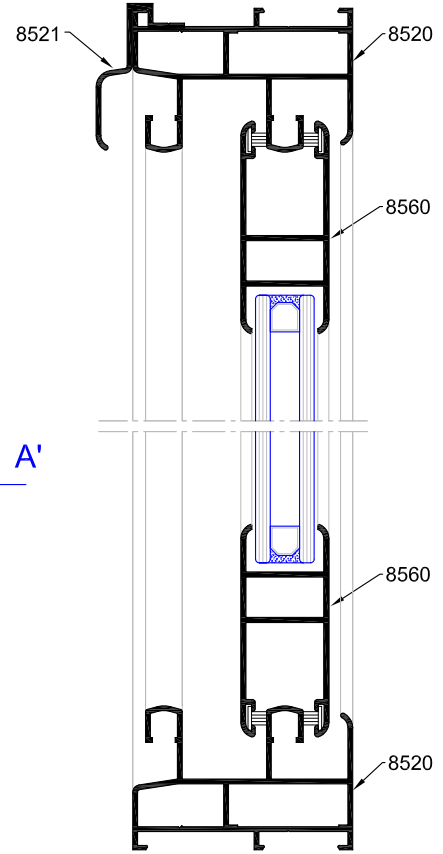
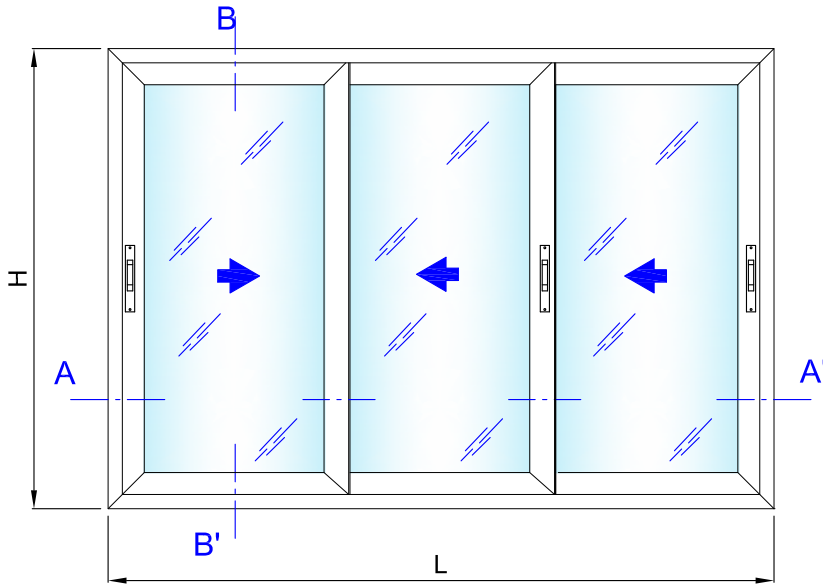

Seccion B-B'

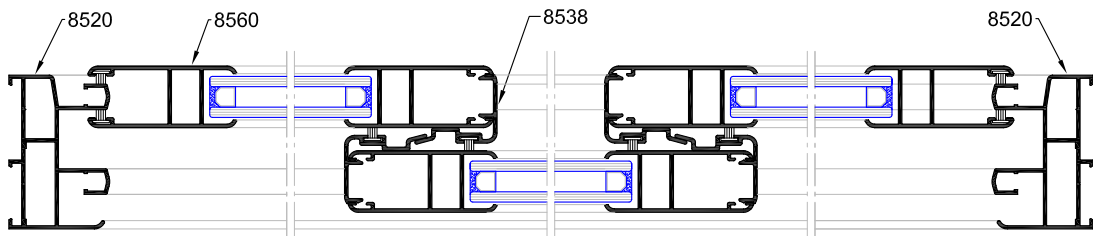

Seccion A-A'



serie

SILVER-60**LISTA DE CORTE Y ACCESORIOS** *Ventana 3 Hojas Correderas Cerco 2 Carriles*Perfiles

DISEÑO	REFERENCIA	DENOMINACION	POSICION	UNIDADES	FORMULA CORTE	TIPO CORTE
	8520	Cerco Perimetral	Horiz.	2	L	
			Vert.	2	H	
	8560/ 8537	Hoja Perimetral Vidrio doble/sencillo	Horiz.	6	$(L - 53) / 3$	
			Vert.	6	H - 62	
	8538	Acople Cruce Hojas	Vert.	4	H - 62	
	8521	Vieriteguas	Horiz.	1	L	

Vidrio

Unds.	Fórmula Corte
3	$(L-241)/3$ H-158

Accesorios

REFERENCIA	DENOMINACION	CANTIDAD	REFERENCIA	DENOMINACION	CANTIDAD
4558	<i>Cierre Embutido c/ condena</i>	3	4109	<i>Escuadra Alineamiento Hoja</i>	24
4102	<i>Rueda Regulable</i>	6	4116	<i>Escuadra Alineamiento Carriles Cerco</i>	8
4553	<i>Juego Cortavientos</i>	2	4038	<i>Escuadra Cerco</i>	4
4107	<i>Emb. Cruce Central</i>	8	4556	<i>Escuadra Hoja</i>	12
4182	<i>Tope Guiador Lateral (Jgo 4)</i>	1	2022	<i>Fin Seal de 7 x 6,5 mm.</i>	4L,8H

serie

SILVER-60

SECCION Ventana 3 Hojas Correderas Cerco 3 Carriles

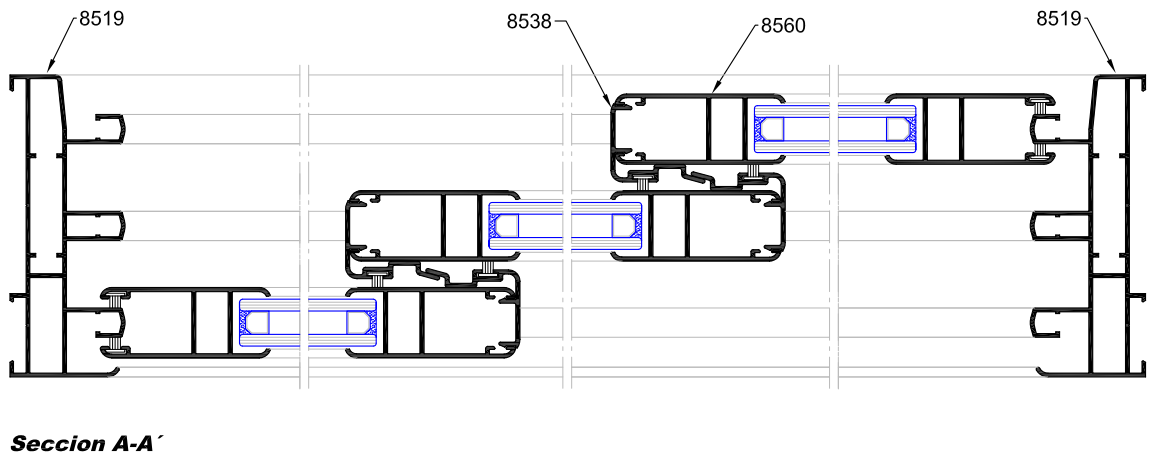
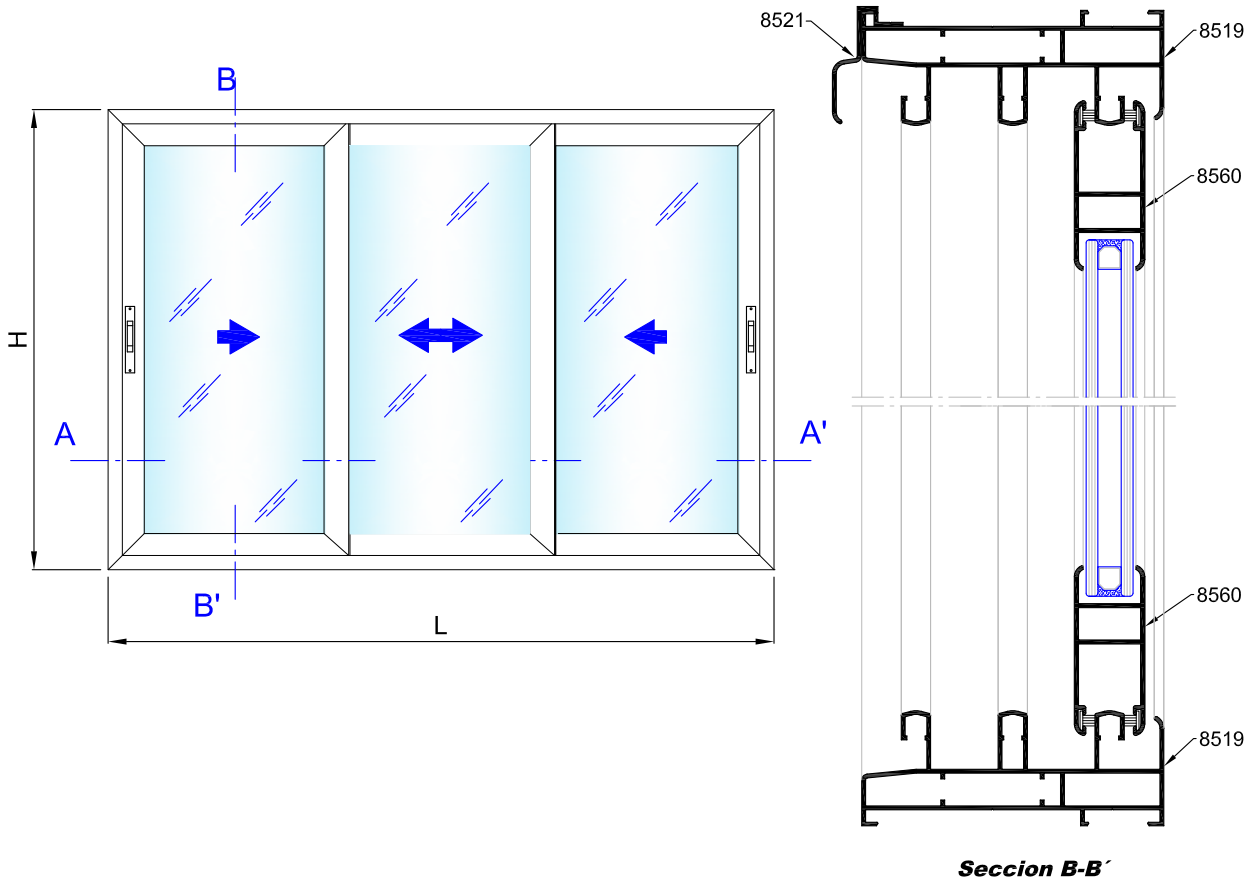











serie

SILVER-60

LISTA DE CORTE Y ACCESORIOS *Ventana 3 Hojas Correderas Cerco 3 Carriles*

Perfiles

DISEÑO	REFERENCIA	DENOMINACION	POSICION	UNIDADES	FORMULA CORTE	TIPO CORTE
	8519	Cerco Perimetral	Horiz.	2	L	
			Vert.	2	H	
	8560/ 8537	Hoja Perimetral Vidrio doble/sencillo	Horiz.	6	$(L + 53) / 3$	
			Vert.	6	H - 62	
	8538	Acople Cruce Hojas	Vert.	4	H - 62	
	8521	Vieriteguas	Horiz.	1	L	

Vidrio

Unds.	Fórmula Corte
3	$(L-241)/3$ H-158

Accesorios

REFERENCIA	DENOMINACION	CANTIDAD	REFERENCIA	DENOMINACION	CANTIDAD
4558	<i>Cierre Embutido c/ condena</i>	2	4109	<i>Escuadra Alineamiento Hoja</i>	24
4102	<i>Rueda Regulable</i>	6	4116	<i>Escuadra Alineamiento Carriles Cerco</i>	12
4553	<i>Juego Cortavientos</i>	2	4038	<i>Escuadra Cerco</i>	8
4107	<i>Emb. Cruce Central</i>	8	4556	<i>Escuadra Hoja</i>	12
4182	<i>Tope Guiador Lateral (Jgo 4)</i>	1	2022	<i>Fin Seal de 7 x 6,5 mm.</i>	4L,8H

serie

SILVER-60

SECCION Ventana 4 Hojas Correderas

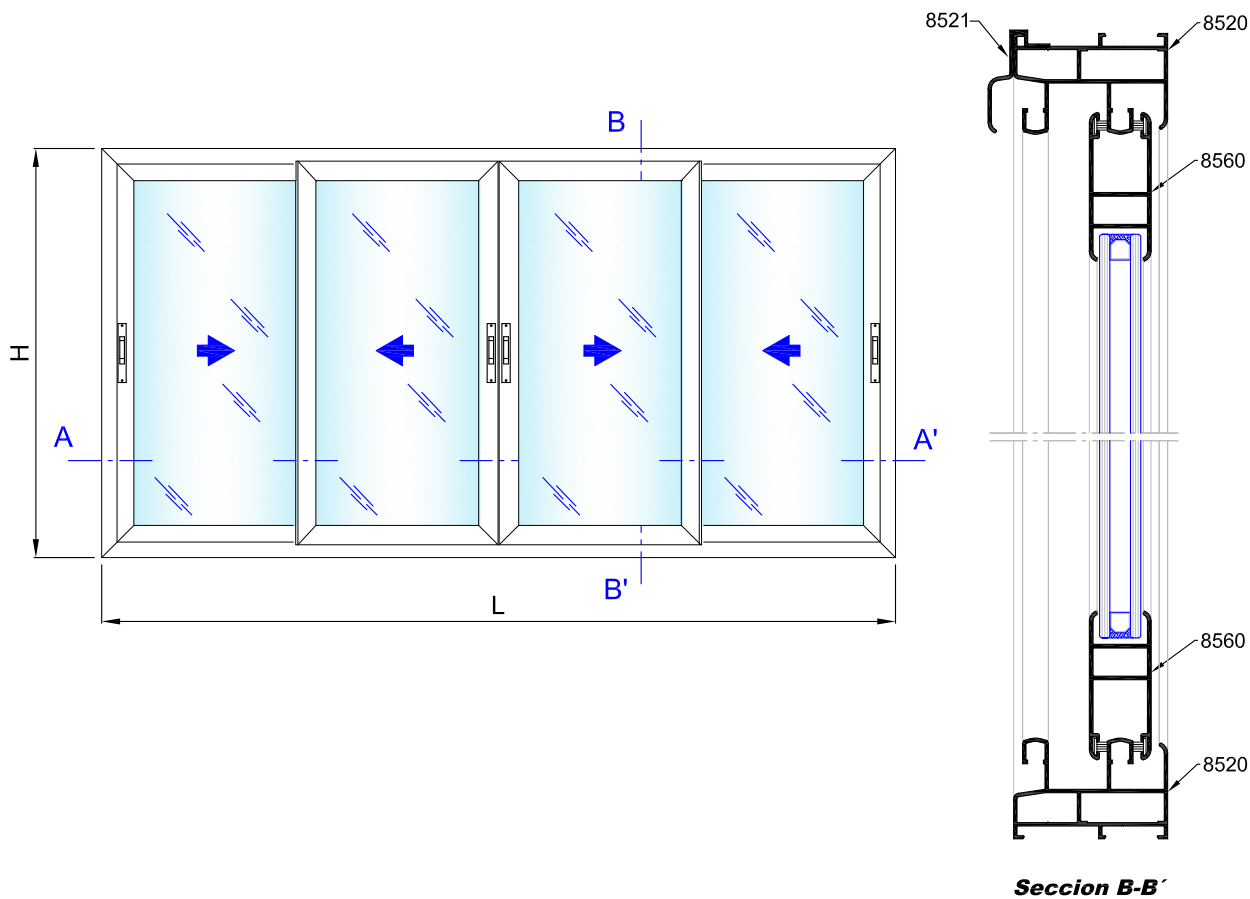













Características Técnicas



serie

SILVER-60**LISTA DE CORTE Y ACCESORIOS** Ventana 4 Hojas CorrederasPerfiles

DISEÑO	REFERENCIA	DENOMINACION	POSICION	UNIDADES	FORMULA CORTE	TIPO CORTE
	8520	Cerco Perimetral	Horiz.	2	L	
			Vert.	2	H	
	8560/ 8537	Hoja Perimetral Vidrio doble/sencillo	Horiz.	8	$(L + 51) / 4$	
			Vert.	8	H - 62	
	8538	Acople Cruce Hojas	Vert.	4	H - 62	
	8569	Acople 4 Hojas	Vert.	1	H - 62	
	8521	Vierteaguas	Horiz.	1	L	

Vidrio

Unds.	Fórmula Corte
4	$(L-341)/4$ H-158

Accesorios

REFERENCIA	DENOMINACION	CANTIDAD	REFERENCIA	DENOMINACION	CANTIDAD
4558	Cierre Embutido c/ condena	4	4109	Escuadra Alineamiento Hoja	32
4102	Rueda Regulable	8	4116	Escuadra Alineamiento Carriles Cerco	8
4553	Juego Cortavientos	2	4038	Escuadra Cerco	4
4107	Emb. Cruce Central	8	4556	Escuadra Hoja	16
4182	Tope Guiador Lateral (Jgo 4)	2	2022	Fin Seal de 7 x 6,5 mm.	4L,10H

serie

SILVER-60

SECCION Ventana 6 Hojas Correderas Cerco 3 Carriles

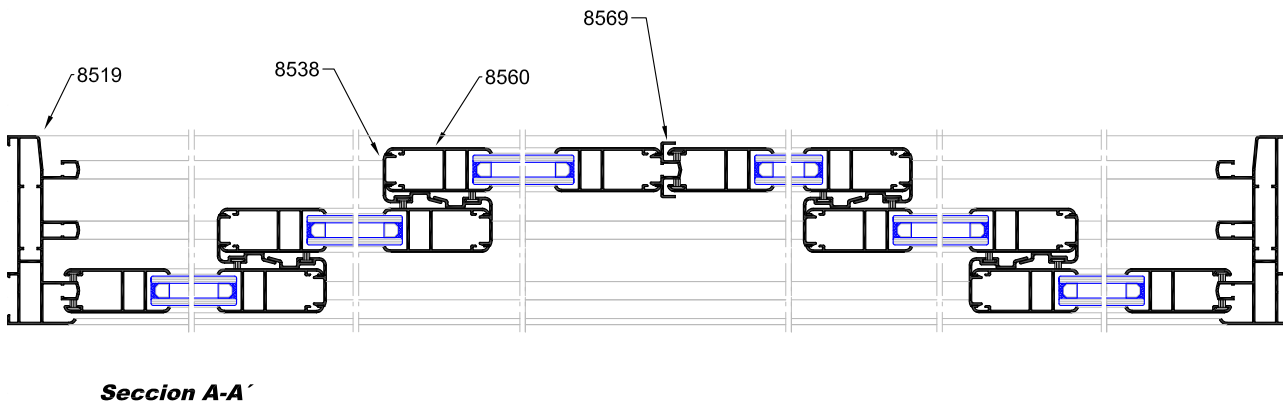
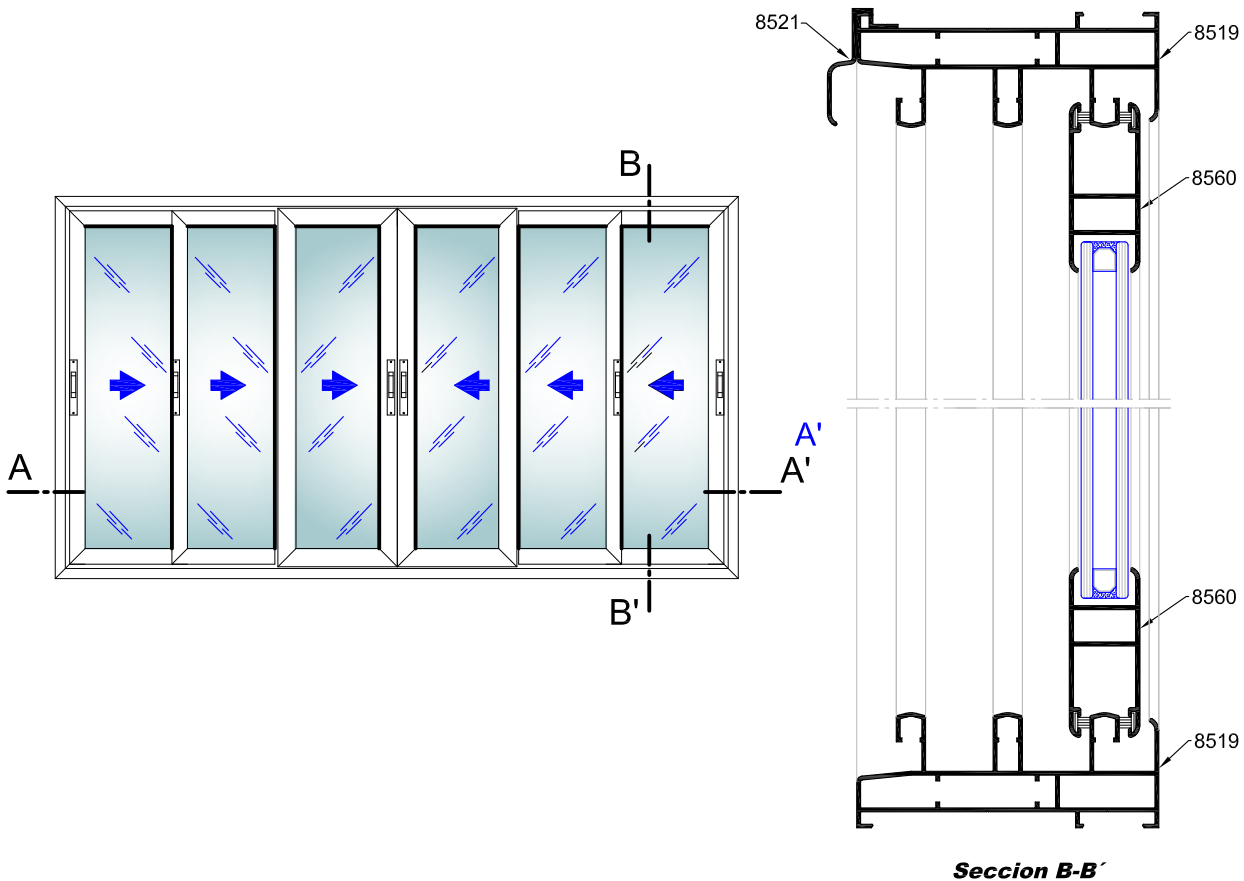













Características Técnicas



serie

SILVER-60**LISTA DE CORTE Y ACCESORIOS** Ventana 6 Hojas Correderas Cerco 3 CarrilesPerfiles

DISEÑO	REFERENCIA	DENOMINACION	POSICION	UNIDADES	FORMULA CORTE	TIPO CORTE
	8519	Cerco Perimetral	Horiz.	2	L	
			Vert.	2	H	
	8560/ 8537	Hoja Perimetral Vidrio doble/sencillo	Horiz.	12	$(L + 164) / 6$	
			Vert.	12	H - 62	
	8538	Acople Cruce Hojas	Vert.	8	H - 62	
	8569	Acople 4 Hojas	Vert.	1	H - 62	
	8521	Vierteaguas	Horiz.	1	L	

Vidrio

Unds.	Fórmula Corte
6	$(L-424)/6$ H-158

Accesorios

REFERENCIA	DENOMINACION	CANTIDAD	REFERENCIA	DENOMINACION	CANTIDAD
4558	Cierre Embutido c/ condena	6	4109	Escuadra Alineamiento Hoja	48
4102	Rueda Regulable	12	4116	Escuadra Alineamiento Carriles Cerco	12
4553	Juego Cortavientos	4	4038	Escuadra Cerco	8
4107	Emb. Cruce Central	16	4556	Escuadra Hoja	24
4182	Tope Guiador Lateral (Jgo 4)	2	2022	Fin Seal de 7 x 6,5 mm.	4L,14H

Serie SILVER - 60 (Hoja 8560)

Lista de Corte

Hoja Perimetral - **8560** (Horizontal)..... (L+ 164) / 6

Hoja Perimetral - **8560** (Vertical)..... H - 62

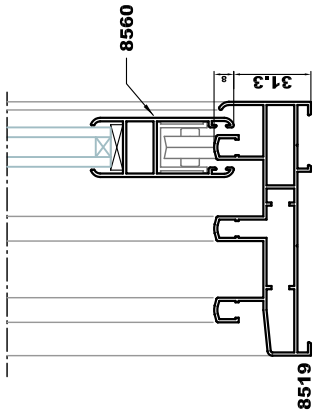

L

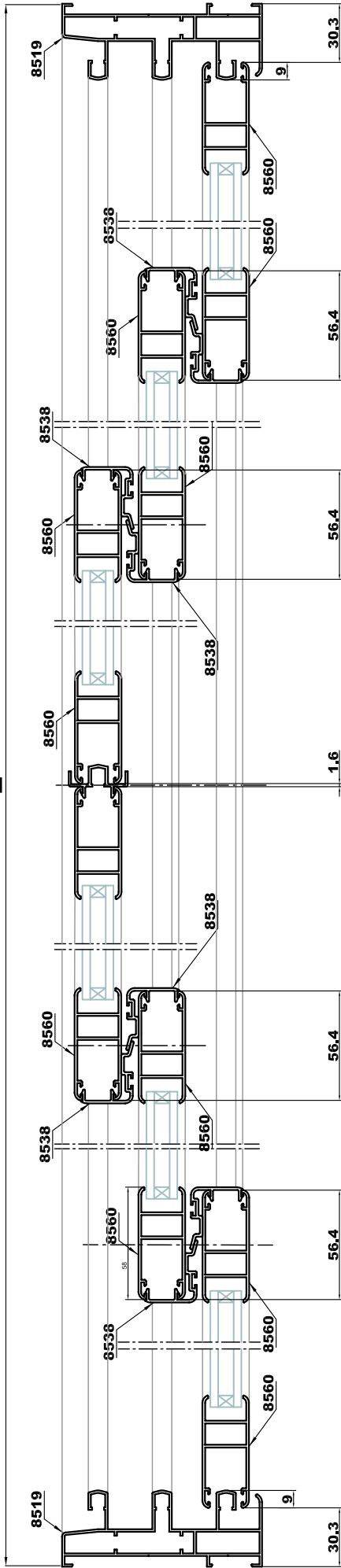

$-30,3 + 56,4 + 56,4 - 1,6 + 56,4 + 56,4 - 30,3 = 163,4 / 6$



DENOMINACIÓN:	CLIENTE / SOLICITADO POR: :
Lista de Corte 6 Hojas en 3 carriles (Hoja 8560)	ALUGOM MADRID, S.A.U.
SERIE:	DIBUJADO POR:
Silver - 60	José Muñoz
UBICACIÓN ARCHIVO	FECHA:
\\sacado\tsacados\1-1\Silver60-70 (1-1).dwg	30-11-2015
	Ref.: PROVISIONAL



serie

SILVER-60

SECCION Ventana 2 Hojas Correderas - Cerco 9116

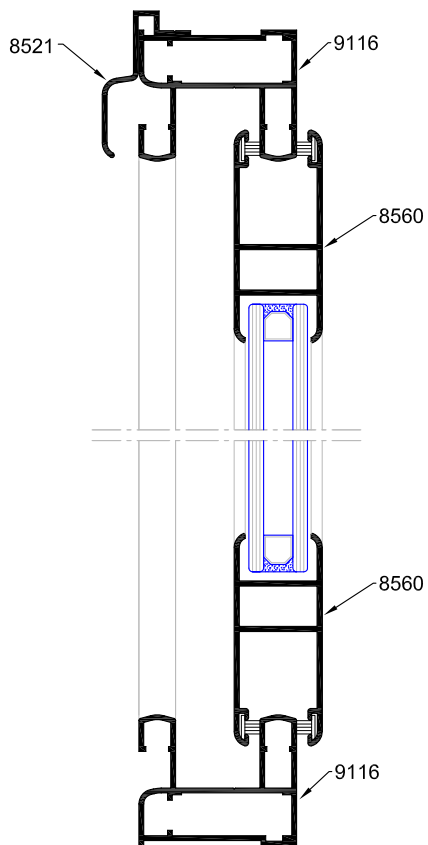
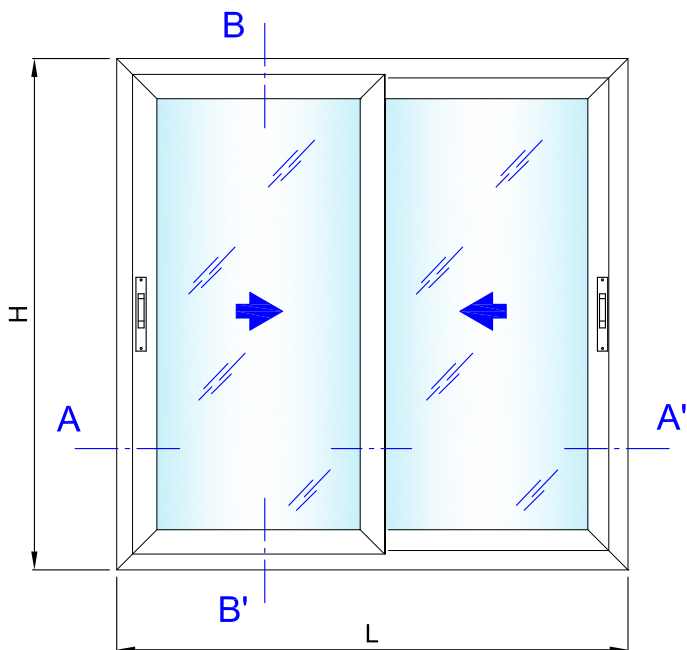

Seccion B-B'

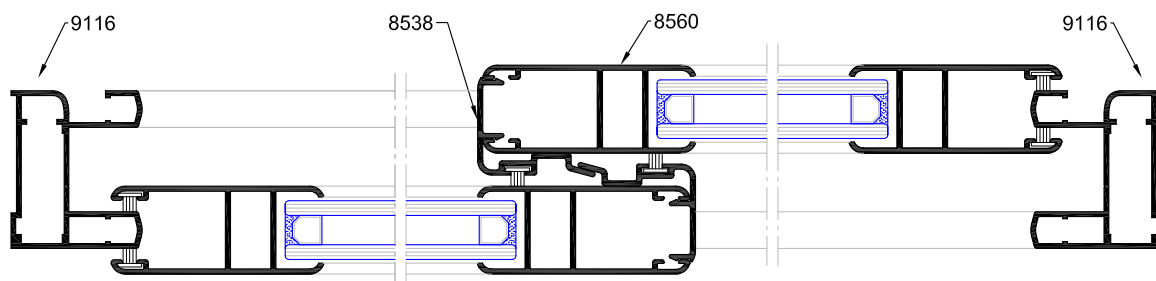

Seccion A-A'

Características Técnicas



serie

SILVER-60**LISTA DE CORTE Y ACCESORIOS** *Ventana 2 Hojas Correderas*Perfiles

DISEÑO	REFERENCIA	DENOMINACION	POSICION	UNIDADES	FORMULA CORTE	TIPO CORTE
	9116	Cerco Perimetral	Horiz.	2	L	
			Vert.	2	H	
	8560/ 8537	Hoja Perimetral Vidrio doble/sencillo	Horiz.	4	$(L - 15) / 2$	
			Vert.	4	H - 54	
	8538	Acople Cruce Hojas	Vert.	2	H - 54	
	8521	Vieriteguas	Horiz.	1	L	

Vidrio

Unds.	Fórmula Corte
2	$(L-193)/2$ H-151

Accesorios

REFERENCIA	DENOMINACION	CANTIDAD	REFERENCIA	DENOMINACION	CANTIDAD
4558	<i>Cierre Embutido c/ condena</i>	2	4109	<i>Escuadra Alineamiento Hoja</i>	16
4102	<i>Rueda Regulable</i>	4	4116	<i>Escuadra Alineamiento Carriles Cerco</i>	8
4553	<i>Juego Cortavientos</i>	1	4038	<i>Escuadra Cerco</i>	4
4107	<i>Emb. Cruce Central</i>	4	4556	<i>Escuadra Hoja</i>	8
4182	<i>Tope Guiador Lateral (Jgo 4)</i>	1	2022	<i>Fin Seal de 7 x 6,5 mm.</i>	4L,6H